

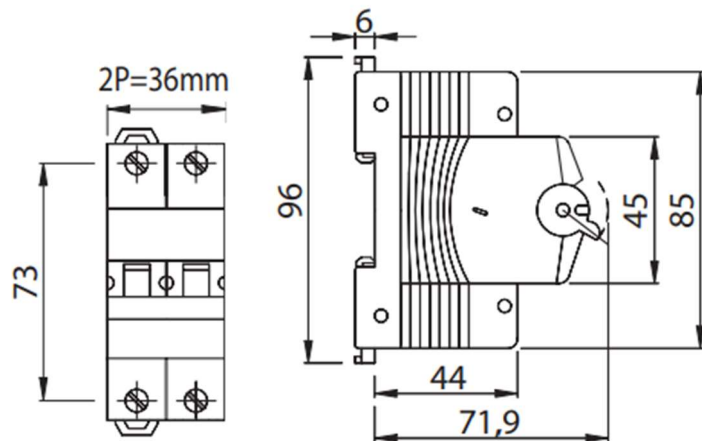

Modulær lastbryter
Antall poler: 2
Antall moduler: 2
Merkestrøm: 63A
Standard: AC-22A
Merkespenning: 240-415AC
Elnr: 1401327

Standard;	EN 60947-3	Frekvens (Hz)	50/60Hz
Merkestrøm (In)	63A	Isolasjonsspenning	500V
Slutte kapasitet	189A	Effekt tap pr pol	2W
Bryte kapasitet	189A	Skrutrekker	Philips
Kortslutning strøm (Icw)	756A	Tiltrekningsmoment	2,5Nm
IP	20	Driftstemperatur	- 5 til + 40° C
		Nominell impulsstøtspenning	4kV
Tverrsnitt en leder kabel	≤ 1x50 - ≤ 2x25 - ≤ 3x16mm ²	Tverrsnitt fleksibel kabel	≤ 1x70 - ≤ 2x35 - ≤ 2x25+1x16mm ²

Dimensjon



Standarder/godkjenninger

